

COMPLEMENTARY



... the Finishing Touch!

ALISEO GERMANY
HOTELPERFEKTION

Little Things Matter Most





COMPLEMENTARY

Das gewisse Etwas, die Liebe zum Detail, unterscheidet Ihr Hotel von anderen. Komfort für Ihre Gäste bedeutet, dass Sie deren Erwartungen mit hohen Standards erfüllen.

Much appreciated attention to details that distinguish your hotel from others. The comforts your guests expect are the standards that you set.

PRESTIGE

Design is in the Details

In Aliseo's moderner und herausragender Handwerkskunst spiegeln sich technische Innovationen wieder, die gleichzeitig durch Ihren hohen Nutzen und die leichte Handhabung bestechen.

Contemporary craftsmanship at its finest, Aliseo's sensible technology and intelligent solutions combine clarity of purpose with utilitarian beauty.





ABSENK-AUTOMATIK & STABILES PEDALSYSTEM

Ein patentiertes Hydrauliksystem ermöglicht das geräuscharme Absenken des Deckels. Das verstärkte Pedal verteilt die Kraft gleichmäßig. Ein solides System, das über 100.000 Betätigungen ermöglicht.

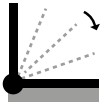

SILENT SOFT CLOSE SYSTEM

Intelligent soft-close function controlled by a patented hydraulic lid system. Rib-reinforced steel pedal distributes foot force equally. Extending service life in upwards of 100,000 steps.



ANTI-FINGERABDRUCK

Hochwertiger Edelstahl mit spezieller Anti-Fingerabdruck-Lackierung. Die Oberfläche bleibt frei von Abdrücken und ist einfacher zu reinigen.



FINGERPRINT RESISTANT

High-quality stainless steel with fingerprint resistant coating keeps the bin clean and easy to maintain.



BEUTELFIXIERUNG

Plastikbeutel lassen sich mittels einer Befestigungsöse am Inneneimer problemlos befestigen.

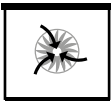

PLASTIC BAG FIXER

Plastic bag fixer helps secure the bag with no visible excess, keeping the bags neat and orderly.



SICHERER STAND

Kunststoffboden mit rutschfesten, oberflächen-schonenden Pads geben dem Eimer Stabilität.



SOLID BASE

Plastic bottom, non-skid base and insulated pads are gentle on the floor and keeps the bin steady.





PRESTIGE



the CLASSIC



030654

PRESTIGE

Hygieneeimer - 3 L

Herausnehmbarer Kunststoffeinsatz

Edelstahl, gebürstet

Step Bin - 3 L

Removable plastic inner bin

Stainless steel, brushed finish

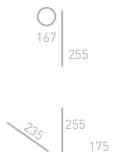



INNENEIMER

Herausnehmbarer, solider Inneneimer vereinfacht das Leeren und die Reinigung.

INNER BUCKET

Durable lift-out inner bucket catches messy drips.



030655

PRESTIGE

Hygieneimer - 5 L
 Herausnehmbarer Kunststoffeinsatz
 Edelstahl, gebürstet
 Step Bin - 5 L
 Removable plastic inner bin
 Stainless steel, brushed finish

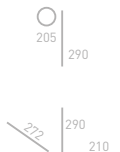



PRESTIGE

VERSTÄRKTES GELENK MIT TRAGEGRIFF
Hygieneeimer kann ohne Bedenken am Haltegriff angehoben und transportiert werden.

STRONG BACK HANDLE
Comfortable and secure handle for positive grip and lift.



Beständiger, robuster Kunststoffdeckel.
Durable dent-proof plastic lid.



030657

PRESTIGE

Hygieneeimer - 5 L
Herausnehmbarer Kunststoffeinsatz
Edelstahl, gebürstet
Step Bin - 5 L
Removable plastic inner bin
Stainless steel, brushed finish

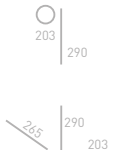



A Contemporary Alternative



030656

PRESTIGE

Hygieneimer - 6 L
 Herausnehmbarer Kunststoffeinsatz
 Edelstahl, gebürstet
 Step Bin - 6 L
 Removable plastic inner bin
 Stainless steel, brushed finish

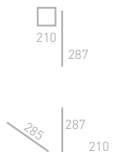



ABNEHMBARER RING
INNENEIMER
OHNE ABDECKUNG

Offener Eimer für mühelose Abfallbeseitigung. Abnehmbarer Ring und Inneneimer mit Abfallbeutelbefixierung und Henkel ermöglichen eine saubere Konzeption.

LIFT-OFF LID
INNER BUCKET
OPEN TOP

Open mouth design for effortless trash discard. Lift-off lid and removable liner with waste bag fixer and sure-grip handle make for fast easy trash disposal.





Modern Cubic Design

030660

PRESTIGE

Abfallbehälter - 9 L
 Herausnehmbarer Kunststoffeinsatz
 Edelstahl, gebürstet

Waste Bin - 9 L
 Removable plastic inner bin
 Stainless steel, brushed finish



EZ STAY BIN

Ideal für Suiten, Apartments oder Ferienwohnungen.
PRESTIGE EZ STAY Hygieneeimer für einen unbeschwerten Aufenthalt.

Ideal for suite, apartment or extended stay applications.
The EZ STAY BIN makes your guest's stay easier.



2-FACH INNENEIMER

Zwei separate Inneneimer für einfache Mülltrennung und Müllentsorgung.

DOUBLE INNER BUCKETS

Double inner liners for easy separation and recycling.



STAY-OPEN-FUNKTION

Komfortable Deckelverankerung bei längerem Gebrauch.

STAY OPEN DESIGN

Lid lock-out for convenient longer term usage.



LANGLEBIG

Extra breites Pedal verteilt die Kraft gleichmäßig. Ein solides Pedalsystem gewährleistet über 100.000 Betätigungen.

DURABLE

Rib-reinforced extra large steel pedal distributes foot force equally, extending service life in upwards of 100,000 steps.

030659

PRESTIGE EZ STAY

Hygieneeimer - 10 L + 9 L

Zwei herausnehmbare Kunststoffeinsätze

Edelstahl, gebürstet

Step Bin - 10 L + 9 L

Two removable plastic inner bins

Stainless steel, brushed finish





030095

Hygieneeimer - 5 Liter
herausnehmbarer Kunststoffeinsatz
Edelstahl, verchromt

Pedal Bin - 5 litre
Removable inner plastic bin
Stainless steel, chrome finish

210 |
290



190036
IVANA

Abfallbehälter - 9 L
Herausnehmbarer Metalleinsatz
Kunstleder, chocolate
Waste Bin - 9 L
Removable metal liner
Fauy leather, chocolate



190025
THE LONDONER

Abfallbehälter - 9 L
Metall mit abnehmbarer Ummantelung
in Kunstleder, taupe
Waste Bin - 9 L
Metal with removable casing
in faux leather, taupe



190026
THE LONDONER

Abfallbehälter - 10 L
Herausnehmbarer Metalleinsatz
Kunstleder, taupe
Waste Bin - 10 L
Removable metal liner
Fauy leather, taupe





030527

Haken
Messing, verchromt
Hook
Brass, chrome finish



030538 030539

Haken
Messing, verchromt
Hook
Brass, chrome finish





740016

Haken
Messing, verchromt
Hook
Brass, chrome finish



710006

Haken
Messing, verchromt
Hook
Brass, chrome finish



320006

Haken
Zink/Edelstahl, verchromt
Hook
Zinc/ stainless steel, chrome finish



330003

Haken
Messeing/Zink/Edelstahl, verchromt
Hook
Brass/ zinc/ stainless steel, chrome finish





HOOK IT UP!



770005

Haken
Messing, verchromt
Hook
Brass, chrome finish



780004

Haken
Messing, verchromt
Hook
Brass, chrome finish



710014

Doppel-Haken
Messing, verchromt
Double Hook
Brass, chrome finish



030472

Doppel-Haken
Messing, verchromt
Double Hook
Brass, chrome finish





690005

Haken
Messing, verchromt
Hook
Brass, chrome finish



730002

Haken
Messing, verchromt
Hook
Brass, chrome finish



710042

Doppel-Haken
Messing, verchromt
Double Hook
Brass, chrome finish



740004

Doppel-Haken
Messing, verchromt
Double Hook
Brass, chrome finish



A Place for Everything



SOAP BASKETS



... mit spezieller Schraubenabdeckung
... with covered screws



030534

Ablage
Messing, verchromt
Shelf
Brass, chrome finish



030532

Ablage
Messing, verchromt
Shelf
Brass, chrome finish



030533

Eck-Ablage
Messing, verchromt
Corner Shelf
Brass, chrome finish





SEIFENKÖRBCHEN



Eckseifenkörbchen
Messing, verchromt
Corner Soap Basket
Brass, chrome finish

030461



030466



Eckseifenkörbchen
Messing, verchromt
Corner Soap Basket
Brass, chrome finish

030509



Eckseifenkörbchen
Messing, verchromt
Corner Soap Basket
Brass, chrome finish

030462





030511

Seifenkörbchen
 Messing, verchromt
 Soap Basket
 Brass, chrome finish



030464

Seifenkörbchen
 Messing, verchromt
 Soap Basket
 Brass, chrome finish



030463

Seifenkörbchen
 Messing, verchromt
 Soap Basket
 Brass, chrome finish





030594

Seifenhalter
Messing, verchromt

Soap Dish
Brass, chrome finish





030614

Seifenspender CARLTON
 Satiniertes Glas. Messing, verchromt
 Soap Dispenser CARLTON
 Iced glass. Brass, chrome finish



030615

Seifenspender MOON
 Satiniertes Glas. Messing, verchromt
 Soap Dispenser MOON
 Iced glass. Brass, chrome finish



070026

CLASSIC
 Seifenspender. Untertischmontage
 Kunststoffbehälter. Messing, verchromt
 Soap Dispenser. Deck top mounting
 Plastic bottle. Brass, chrome finish



On Call

*there ...
when you need it*





... the necessary accessory

... mit spezieller Schraubenabdeckung
... with covered screws



Ablagefläche
Shelf dimensions
160 x 95 mm



030652
ON CALL

Papierrollenhalter mit
Ablagefläche für Mobiltelefone
Edelstahl, glänzend

Toilet Roll Holder
With shelf for mobile phones
Stainless steel, shiny finish





030447 - horizontal

030495 - vertical

Einbau-Papierrollenhalter
Messing, verchromt
Built-in Toilet Roll Holder
Brass, chrome finish

Horizontale Montage
Horizontal mounting



030412

Reserverollenhalter
Messing, verchromt
Spare Roll Holder
Brass, chrome finish



030438

Einbau-Papierrollenhalter
Messing, verchromt
Built-in Toilet Roll Holder
Brass, chrome finish



740018

WC-Bürstengarnitur. Standmodell
Edelstahl verchromt
Toilet Brush Holder. Free standing
Stainless steel, chrome finish





030416

Wäscheleine
Messing, verchromt
Clothes Line
Brass, chrome finish

90 $\frac{\text{max. 2,7m}}{\text{O}}$ 66 x 31 O



030494

Wäscheleine
Messing, verchromt
Clothes Line
Brass, chrome finish

95 $\frac{\text{max. 2,7m}}{\square}$ 45 x 65 \square



TISSUE DISPENSERS



030448

Kosmetiktuchspender
Messing, verchromt
Tissue Dispenser
Brass, chrome finish



030506

Kosmetiktuchspender CUBE
Kunststoff, verchromt
Tissue Dispenser CUBE
Plastic, chrome finish



030174

Kosmetiktuchspender
ABS-Kunststoff, verchromt
Tissue Dispenser
ABS-plastic, chrome finish



030628

Hygienebaghalter
Kunststoff, verchromt
Sanitary Bag Dispenser
Plastic, chrome finish



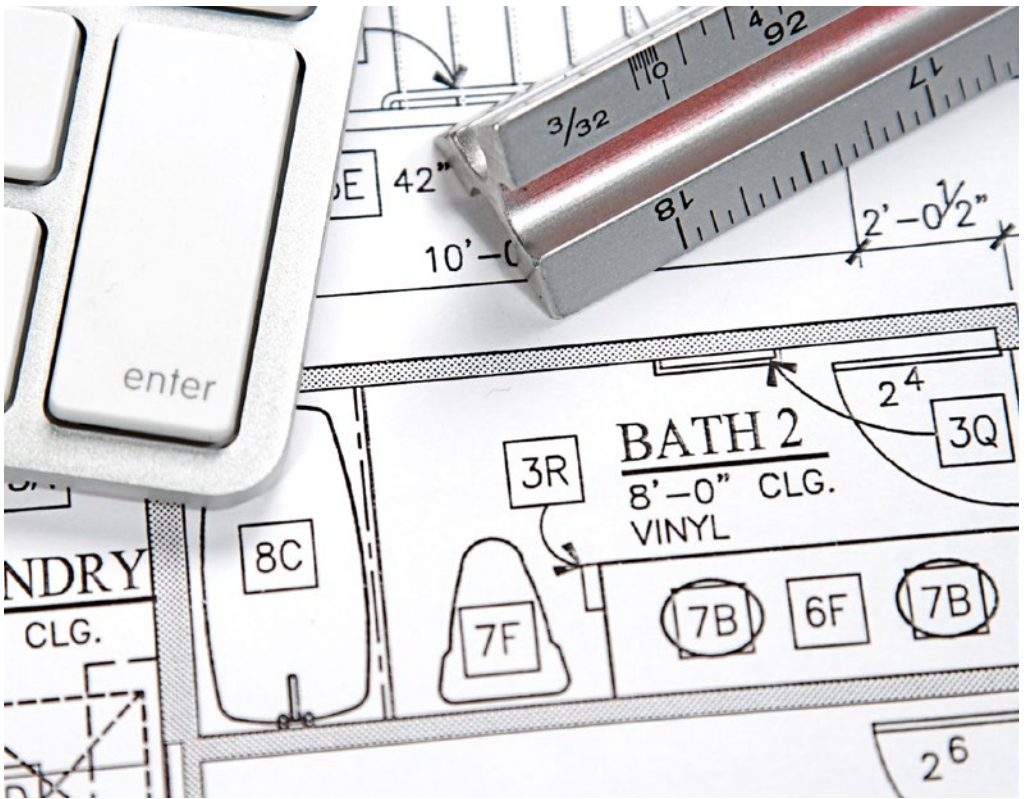

BUILT-IN



030449

Einbau- Kosmetiktuchspender
Messing, verchromt

Built-in Tissue Dispenser
Brass, chrome finish



030415

Einbau- Kosmetiktuchspender
Messing, verchromt

Built-in Tissue Dispenser
Brass, chrome finish







030490
BOHEMIA

Mechanisch - Extra groß
Großzügige Trittlfläche
Verzerrungsfreie Glasscheibe
Solide Konstruktion
Tragkraft max. 160 kg
Teilung 500 g
Anzeige in Kilo und Pfund
Material: Metall, korrosions-
geschützte Emailbeschichtung

Mechanical - Extra Large
Comfortable platform
Fog-free glass lens
Durable construction
Capacity max. 160 kg
Graduation 500 g
Display kg and lbs
Material: metal / corrosion
resistant enamelled coating

435  320 | 68

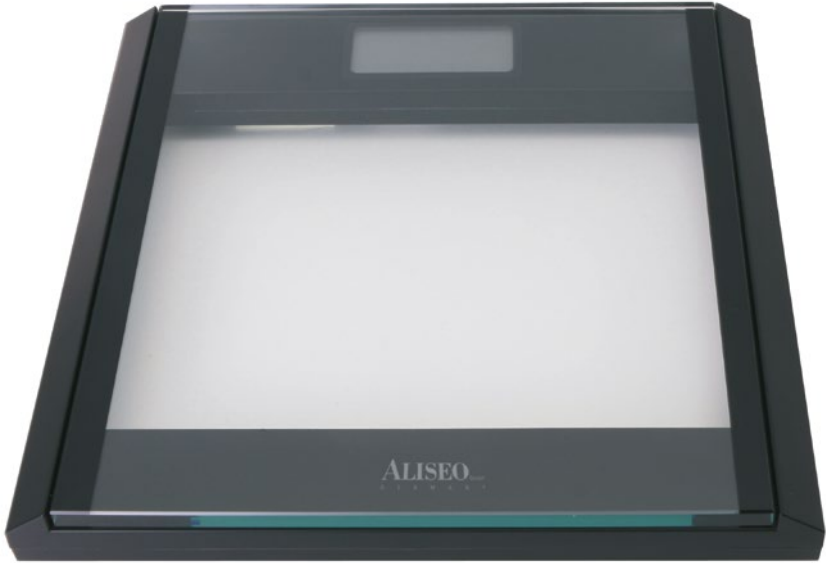

030544
TEMPO

Elektronisch
8-mm-starkes Sicherheitsglas
Tragkraft max. 180 kg
Teilung 100 g
Umschaltbar auf Pfund (lbs)
4 Gewichtssensoren
Automatische Abschaltung
80 x 40 mm Display-Anzeige mit
blauer Hintergrundbeleuchtung
4x AAA Batterien
Material Unterteil: ABS Kunststoff

Electronic
8 mm-thick safety glass
Capacity max. 180 kg
Graduation 100 g
Switchable to pounds (lbs)
4 integrated sensors
Auto shut-off
80 x 40 mm LCD display
with blue backlight
4x AAA batteries
Material underpart: ABS plastic





030653
STEP SCALE

Elektronisch
6-mm-starkes Sicherheitsglas
Tragkraft max. 150 kg
Teilung 100 g
Umschaltbar auf Pfund (lbs)
Step-on-Funktion
4 Gewichtssensoren
Automatische Abschaltung
1 x 3V Lithium Batterie
Material Rahmen und Unterteil:
ABS Kunststoff

Electronic
6 mm-thick safety glass
Capacity max. 150 kg
Graduation 100 g
Switchable to pounds (lbs)
Step-on technology
4 integrated sensors
Auto shut-off
1 x 3V lithium battery
Material frame and underpart:
ABS plastic





030626
NEVIS

Elektronisch
6-mm-starkes Sicherheitsglas
Tragkraft max. 150 kg
Teilung 100 g
Umschaltbar auf Pfund (lbs)
Step-on-Funktion
4 Gewichtssensoren
Automatische Abschaltung
3 x 1,5V-AAA-Batterien
Material Unterteil: ABS-Kunststoff

Electronic
6 mm-thick safety glass
Capacity max. 150 kg
Graduation 100 g
Switchable to pounds (lbs)
Step-On technology
4 integrated sensors
Auto shut-off
3 x 1.5V-AAA batteries
Material underpart: ABS plastic

338  330 | 21/35



030475
FUTURA

Elektronisch
6-mm-starkes Sicherheitsglas
Tragkraft max. 200 kg
Teilung 100 g
Umschaltbar auf Pfund (lbs)
4 Gewichtssensoren
Automatische Abschaltung
Long-life Lithium Batterie
Material Unterteil: Korrosionsgeschützte Epoxid- Kunststoffbeschichtung

Electronic
6 mm-thick safety glass
Capacity max. 200 kg
Graduation 100 g
Switchable to pounds (lbs)
4 integrated sensors
Auto shut-off
Long-life Lithium battery
Material underpart: Corrosion resistant Epoxy-plastic coating





Have a Seat



030089

Badezimmerhocker PURI
 Sitz: ABS-Kunststoff, weiß / Gestell: Metall, verchromt
 Bathroom Stool PURI
 Seat: ABS-plastic, white / Legs: Metal, chrome finish

○
 305 | 400



030485

Badezimmerhocker ZANZIBAR
 Sitz: PVC, weiß, gepolstert / Gestell: Metall, verchromt
 Bathroom Stool ZANZIBAR
 Seat: PVC, white, padded / Legs: Metal, chrome finish

□
 335 | 450



030483

Badezimmerhocker ANTIGUA
 Sitz: PVC, weiß, gepolstert / Gestell: Metall, verchromt
 Bathroom Stool ANTIGUA
 Seat: PVC, white, padded / Legs: Metal, chrome finish

○
 348 | 450

*Safety
First*





Formvollendete Stärke, Sicherheit und Stabilität

- 3-Punkt-Befestigung
- Zugbelastung bis zu 190 kg
je nach Wandbauart

Stylish strength, safety and stability

- Positive 3 point fixation system
- Up to 190 kilo pull-weight capacity
depending on wall construction

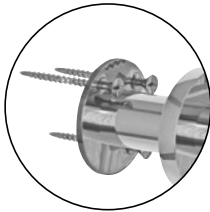

710054

Sicherheits-Haltegriff
Safety Grab Bar

125	57
	507



710053

Sicherheits-Haltegriff
Safety Grab Bar

125	57
	357

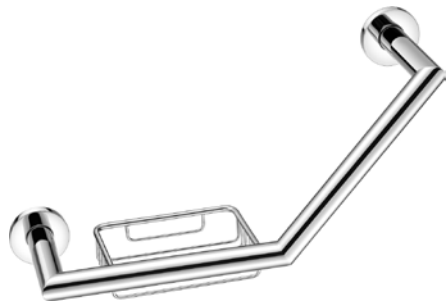

710056

Sicherheits-Haltegriff mit Seifenkörbchen.
Wechselseitige Montage
Safety Grab Bar with Soap Basket.
Adjusts to left and right hand installations

125	204
	413



SICHERHEITS-HALTEGRIFFE



030409

Sicherheits-Haltegriff
Messing, verchromt
Grab Bar
Brass, chrome finish



030408

Sicherheits-Haltegriff
Messing, verchromt
Grab Bar
Brass, chrome finish



030411

Sicherheits-Haltegriff
Messing, verchromt
Grab Bar
Brass, chrome finish



030410

Sicherheits-Haltegriff
Messing, verchromt
Grab Bar
Brass, chrome finish



SAFETY GRAB BARS



770018
Sicherheits-Haltegriff
Safety Grab Bar



740023
Sicherheits-Haltegriff
Safety Grab Bar



740026 - mit Seifenkörbchen - with soap basket
740025 - ohne Seifenkörbchen - without soap basket

Sicherheits-Haltegriff mit Seifenkörbchen. Wechselseitige Montage
Safety Grab Bar with Soap Basket. Adjusts to left and right hand installations





Stay Dry

SHOWER CURTAINS



MENUETTO

Satingewebe
100 % Polyester
Imprägniert, gechintzt
Wasser abweisend
Maschinenwäsche
Ohne Duschvorhänger

MENUETTO

Satin
100 % Polyester
Impregnated, coated
Water repellent
Machine-washable
Without curtain rings

Größe / Size		Farbe / Colour	Art.
Breite x Höhe in cm Width x Height in cm			
120 x 200		weiß / white	120428
180 x 200		weiß / white	120251
180 x 180		weiß / white	120258
120 x 200		jasmin / jasmine	120314
180 x 200		jasmin / jasmine	120272
180 x 180		jasmin / jasmine	120278

► Duschvorhänger
siehe nächste Seite

► Shower curtain rings
see next page



PACO

100 % Polyester
Impregnated, coated
Water repellent
Machine-washable
Without curtain rings

PACO

100 % Polyester
Imprägniert, gechintzt
Wasser abweisend
Maschinenwäsche
Ohne Duschvorhänger

Größe / Size		Farbe / Colour	Art.
Breite x Höhe in cm Width x Height in cm			
120 x 200		weiß / white	120356
180 x 200		weiß / white	120257
180 x 180		weiß / white	120253
120 x 200		champagner / champagne	120254
180 x 200		champagner / champagne	120374
180 x 180		champagner / champagne	120364

► Duschvorhänger
siehe nächste Seite

► Weitere Farben auf Anfrage

► Shower curtain rings
see next page

► Other colours upon request

SHOWER CURTAINS



KITTY
100 % Polyvinylchlorid
(PVC)
Wasserdicht
Maschinenwäsche
Ohne Duschvorhänge

KITTY
100 % Polyvinylchloride
(PVC)
Water-proof
Machine-washable
Without curtain rings

Größe / Size	Farbe / Colour	Art.
Breite x Höhe in cm Width x Height in cm		
120 x 200 	weiß / white	120267
180 x 200 	weiß / white	120261

► Duschvorhänge
siehe folgend

► Shower curtain rings
see following



DECO-UNIVERSAL
Stange: ø 25 mm
Material: Aluminium

DECO-UNIVERSAL
Bar: ø 25 mm
Material: Aluminium



VORHANGRINGE
Material: Polypropylen, weiß
Duschvorhang Breite 120 cm - 8 Ringe
Duschvorhang Breite 180 cm - 12 Ringe

CURTAIN RINGS
Material: Polypropylene, white
Shower curtain width 120 cm - 8 rings
Shower curtain width 180 cm - 12 rings



120002





Verpackungsinhalt 12 Stück
Contents 12 pcs.

Größe / Size in cm	Farbe / Colour	Art.
75 - 125 	weiß / white	120172
	chrom / chrome	120173
universal: 90 x 90, 170 x 75, 90 x 80 x 90		
	weiß / white	120181
	chrom / chrome	120176
Deckenstütze / Ceiling Support		
	weiß / white	120183
60 cm	chrom / chrome	120182



MIRAGE
Integrierte Druckknopfleiter
Keine Ringe erforderlich
Stange: 40 x 17 mm
Material: Aluminium

MIRAGE
Integrated sliders
Rings are not necessary
Rings: 40 x 17 mm
Material: Aluminium

Größe / Size in cm	Farbe / Colour	Art.
75 - 125 	weiß / white	120185
	chrom / chrome	120184
125 - 210 	weiß / white	120188
	chrom / chrome	120187
90 x 90 	weiß / white	120204
	chrom / chrome	120203
170 x 75 	weiß / white	120206
	chrom / chrome	120205
Deckenstütze / Ceiling Support		
	white	120189
60 cm	chrome	120198



OUR GREEN COMMITMENT

Als "Environmentally Conscious Company" (ECCO) widmet sich Aliseo der Sicherstellung von nachhaltiger, umweltpositiver Geschäftsverfahren und erfüllt den Qualitätsmanagementstandard der ISO Norm 9001:2008.

Aliseo verfolgt weiterhin die Leitsätze, dargelegt vom Gas Protocol Accounting and Reporting Agreements, das sich zum Ziel gesetzt hat, die Belastung der Unternehmen auf die Umwelt so minimal wie möglich zu halten, indem Aliseo seine internen und externen Prozesse kontinuierlich beobachtet.

Aliseo unterliegt der europäischen Richtlinie für elektrische und elektronische Abfallbeseitigung und der Richtlinie zur Vermeidung von Giftstoffen. Recyclingfähige Materialien werden verwendet, wo immer es möglich ist.

As an Environmentally Conscious Company (ECCO), Aliseo is dedicated to ensuring sustainable and environmentally positive business practices and conforms to the quality management standards as defined by ISO 9001:2008.

Aliseo also abides by the guidelines as set forth by the Gas Protocol Accounting and Reporting Agreement; a company wide program that strives to minimize our operational impact on the environment through a continuous monitoring of on-going internal and external processes.

Aliseo complies with the European Directive on Waste Electrical and Electronic Equipment. In addition, all Aliseo's products comply with the European Directive on the Restriction of Hazardous Substances. Where appropriate recyclable materials are used.



ALISEO GmbH
G E R M A N Y

Leutkirchstraße 63, 77723 Gengenbach, Germany
Tel. +49 (0) 78 03-60 279-0
Fax +49 (0) 78 03-60 279-30
Internet: www.aliseo.de
E-Mail: info@aliseo.de